

# Data Sheet



Article number: 204080M1060A1SK

Description: E+G levelling foot  
GN 40-80-M10-60-A1-SK

Note: SK With nut, External hexagon at the bottom

## Measures

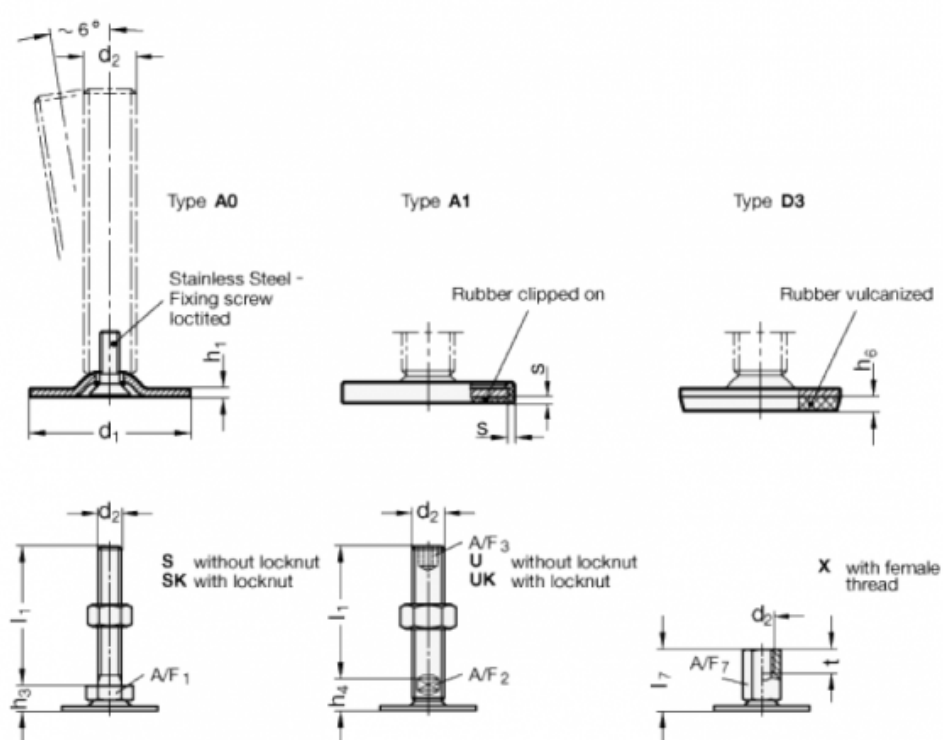

A/F1	=	17
d1	=	80
d2	=	M10
h1	=	3
h3	=	12
h6	=	
l1	=	60
s	=	2